

Part number:

HYDROMA

HYDRAULICKÉ SYSTÉMY

**HIDROMA
SYSTEMS**

UKŁADY HYDRAULICZNE

HYDROMA

ГИДРАВЛИЧЕСКИЕ СИСТЕМЫ

3/2 ways/positions flow diverters L705... (VS81-VS82-VS85)

RE 18302-02

Edition: 10.2017

Replaces: 02.2016



Size 6

Series 00

Maximum operating pressure 310 bar (4500 psi)

Maximum flow 60 l/min (15.85 gpm)

Ports G 3/8 - G 1/2 - SAE8

General specifications

- 3 way 2 position valve.
- Directional spool valve with direct solenoid control.
- Hydraulic / pneumatic pilot, or manual push and twist control available as option.
- Control spool operated by solenoid, with easily removable coil fastened by a ring nut.
- Wet pin tube for DC coil, with push rod for mechanical override in case of voltage shortage.
- Unrestricted 360° orientation of DC coil.
- Control spool held in normal position by return spring.
- Optional manual override (push-button or screw type).
- Connectors available: DIN 43650 – ISO 4400, AMP Junior, DT04-2P (Deutsch), Free leads.

Contents

Ordering details	2
Symbols	2
Functional description	3
Technical data	3
Characteristic curves	5
External dimensions and fittings	6
Electric connection	7

Ordering details

01	02	03	04	05	06	07	08
L	7	05					0

Family	
01	Compact directional valve
	L

Type	
02	Flow diverters
	7

Ports		
03	G3/8 DIN 3852	3
	G1/2 DIN 3852	4
	3/4-16 UNF-2B (SAE8)	C

Control type		
04	Solenoid (coil C48) without manual override	11
	Solenoid (coil C48) with push-button type manual override	1P
	Solenoid (coil C48) with screw type manual override	1F
	Hydraulic / pneumatic control ¹⁾	P1
	Manual push and twist control	H1

Spool variants		
05	3 way / 2 position	3_

Drain type		
06	Internal drain	I
	External drain	E

Voltage supply		31	07	03	01	00	
07	Manual push and twist control	-	-	-	-	-	SG
	Without coil	-	-	-	-	•	00
	12 V DC	•	•	•	•	-	OB
	13 V DC	-	•	-	•	-	AD
	24 V DC	•	•	•	•	-	OC
	27 V DC	-	•	-	•	-	AC
	48 V DC	-	-	-	•	-	OD

Electric connections		
08	Without coils	00
	With coils, without mating connector DIN EN 175301-803 ²⁾	01
	With coils, with bi-directional diode, without mating connector vertical Amp-Junior	03
	With coils, with bi-directional diode, without mating connector DT04-2P	07
	With coils and bipolar sheathed lead 350mm (13,8 in) long	31

• = Available - = Not available

Symbols

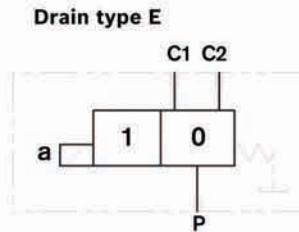
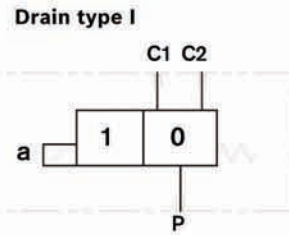

Spool variants

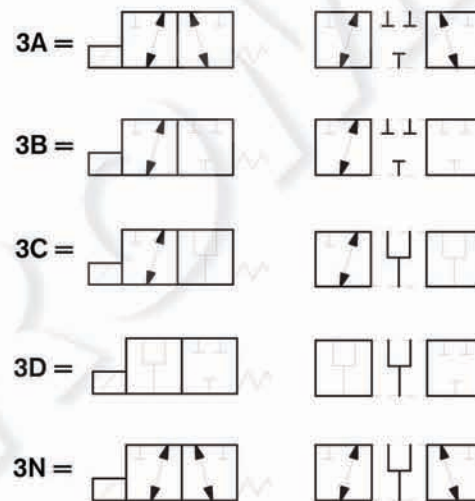

¹⁾ Minimum pressure 4 bar (58psi) with external drain (E), maximum pressure 200 bar (2901psi). With internal drain (I), at the minimum pressure (4 bar - 58psi), add the working pressure with ratio of 6,5:1. Example: With working pressure 100 bar (1450psi), minimum pilot pressure is 19.38 bar (281psi) $((100:6,5) + 4$ bar (58psi)).

²⁾ For connectors ordering code see data sheet RE 18325-90.

Functional description

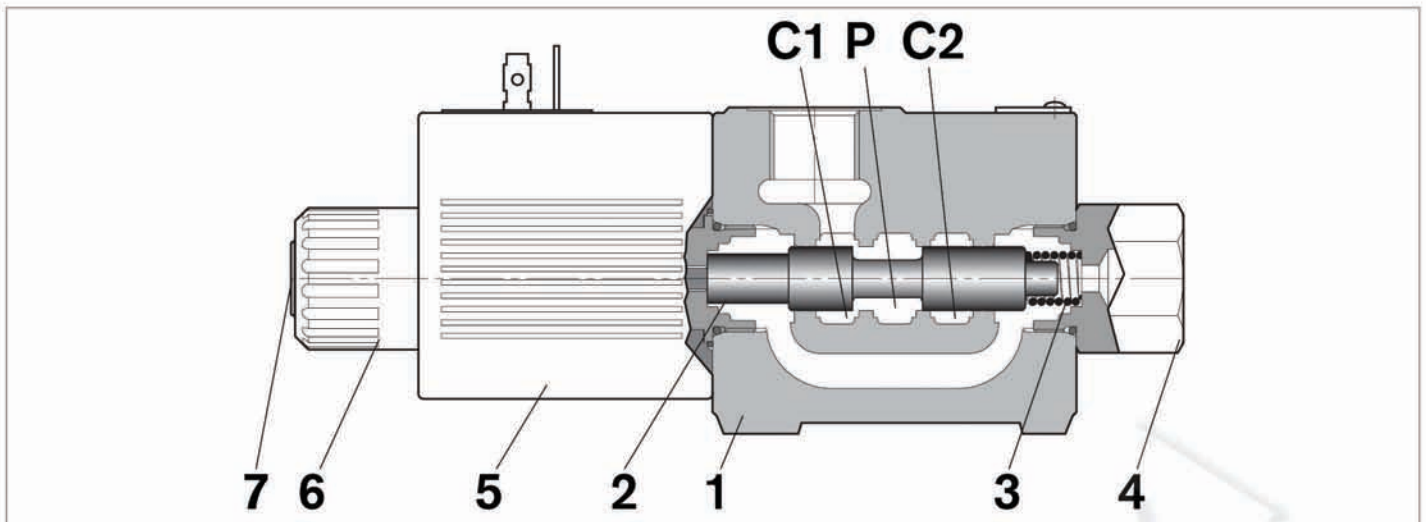

A valve basically consists of a housing (1), a control spool (2), a return spring (3) and a solenoid (5). It is designed to select which one of two circuits (C1 or C2) is to be supplied with the oil delivered from one single hose (P): with spool in position "0", when the solenoid is de-energized, the flow goes from P to C1, with spool in position "1", when the solenoid is energized the flow goes from P to C2.

With the coil de-energized, the return spring (3) pushes

back the spool (2) and holds it in position "0".

The coil (5) is fastened to the tube by the ring nut (6).

The manual override (7) allows to shift the spool (2) also in case of voltage shortage.

An external drain, to be connected to tank, ensures shifting operations also at higher working pressure.

Hydraulic / pneumatic pilot control, or manual push and twist control for spool shifting are available upon request.

Technical data

General		
Valve weight	kg (lbs)	2.06 (4.54)
Ambient Temperature	°C (°F)	-20....+50 (-4....+122) (NBR seals)
MTTFD		150 years see RE 18350-51
Hydraulic		
Maximum pressure with external drain ("E" type)	bar (psi)	310 (4500)
Maximum pressure with internal drain ("I" type)	bar (psi)	250 (3625)
Maximum flow	l/min (gpm)	60 (15.85)
Hydraulic fluid		
General properties: it must have physical lubricating and chemical properties suitable for use in hydraulic systems such as, for example:		Mineral oil based hydraulic fluids HL (DIN 51524 part 1). Mineral oil based hydraulic fluids HLP (DIN 51524 part 2). For use of environmentally acceptable fluids (vegetable or polyglycol base) please consult us.
Fluid Temperature	°C (°F)	-20....+80 (-4....+176) (NBR seals)
Permissible degree of fluid contamination		ISO 4572: $\beta_x \geq 75$ X = 12...15 ISO 4406: class 20/18/15 NAS 1638: class 9
Viscosity range	mm ² /s	5....420
Internal leakage with 100 bar (1450 psi) secondary pressure at C	cc/min (in ³ /min)	min.10 (0.61) max. 20 (1.2)

4 **L705... (VS81-VS82-VS85)** | 3/2 ways/positions flow diverters
 Technical data

Electrical						
Voltage type		DC				
Voltage tolerance (nominal voltage)	%	-10 +10				
Duty		Continuous, with ambient temperature ≤ 50°C (122°F)				
Coil wire temperature not to be exceeded	°C (°F)	150 (302)				
Insulation class		H				
Compliance with		Low Voltage Directive LVD 73/23/EC (2006/95/EC), 2004/108/EC				
Coil weight with DIN 43650 – ISO 4400 connector	kg (lbs)	0.215 (0.44)				
Voltage	V	12	13	24	27	48
Voltage type		DC	DC	DC	DC	DC
Power consumption	W	36	36	36	36	36
Current (nominal at 20 °C (68 °F))	A	3.0	2.77	1.53	1.32	0.75
Resistance (nominal at 20 °C (68 °F))	Ω	3.97	4.68	15.67	20.42	63.60

Note

For applications with different specifications consult us

	Voltage [V]	Connector type	Coil description	Marking	Coil Mat no.
OB 01	12 DC	EN 175301-803 (Ex. DIN 43650)	C4801 12DC	12 DC	R933000063
OB 03	12 DC	AMP JUNIOR	C4803 12DC	12 DC	R933000065
OB 07	12 DC	DEUTSCH DT 04-2P	C4807 12DC	12 DC	R933000068
OB 31	12 DC	Cable 350 mm long	C4831 12DC	12 DC	R933000064
AD 01	13 DC	EN 175301-803 (Ex. DIN 43650)	C4801 13DC	13 DC	R933000069
AD 07	13 DC	DEUTSCH DT 04-2P	C4807 13DC	13 DC	R933000073
OC 01	24 DC	EN 175301-803 (Ex. DIN 43650)	C4801 24DC	24 DC	R933000076
OC 03	24 DC	AMP JUNIOR	C4803 24DC	24 DC	R933000071
OC 07	24 DC	DEUTSCH DT 04-2P	C4807 24DC	24 DC	R933000075
OC 31	24 DC	Cable 350 mm long	C4831 24DC	24 DC	R933000070
AC 01	27 DC	EN 175301-803 (Ex. DIN 43650)	C4801 27DC	27 DC	R933000077
AC 07	27 DC	DEUTSCH DT 04-2P	C4807 27DC	27 DC	R933000074
OD 01	48 DC	EN 175301-803 (Ex. DIN 43650)	C4801 48DC	48 DC	R933000078

Characteristic curves

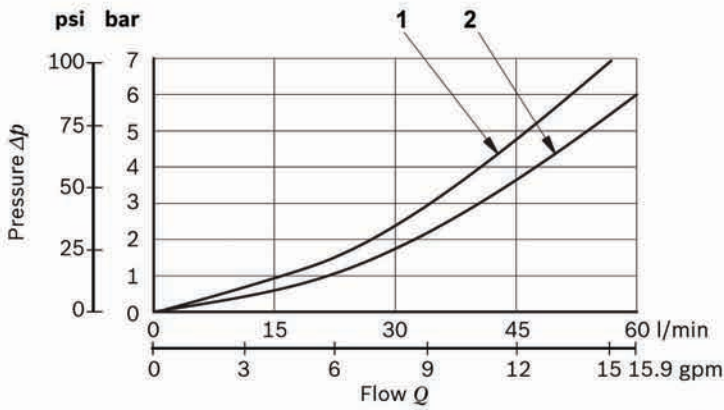

Model	Curve no.
VS 81	1
VS 82/85	2

Measured with hydraulic fluid ISO-VG32 at $45^\circ \pm 5^\circ \text{C}$ ($113^\circ \pm 9^\circ \text{F}$); ambient temperature 20°C (68°F).

DI-DE performance limits

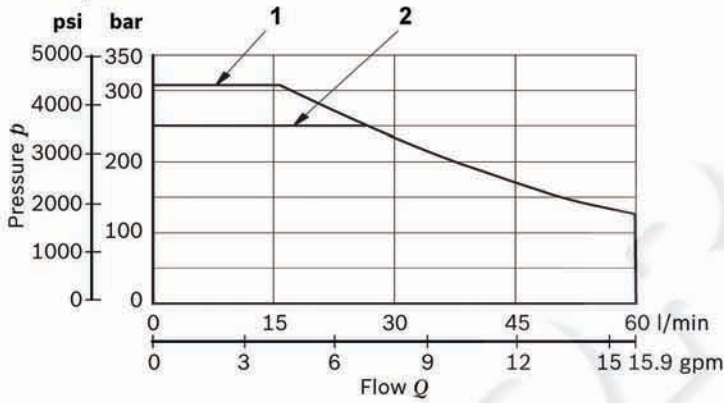

Drain type	Curve No.
External (-E-)	1
Internal (-I-)	2

External dimensions and fittings

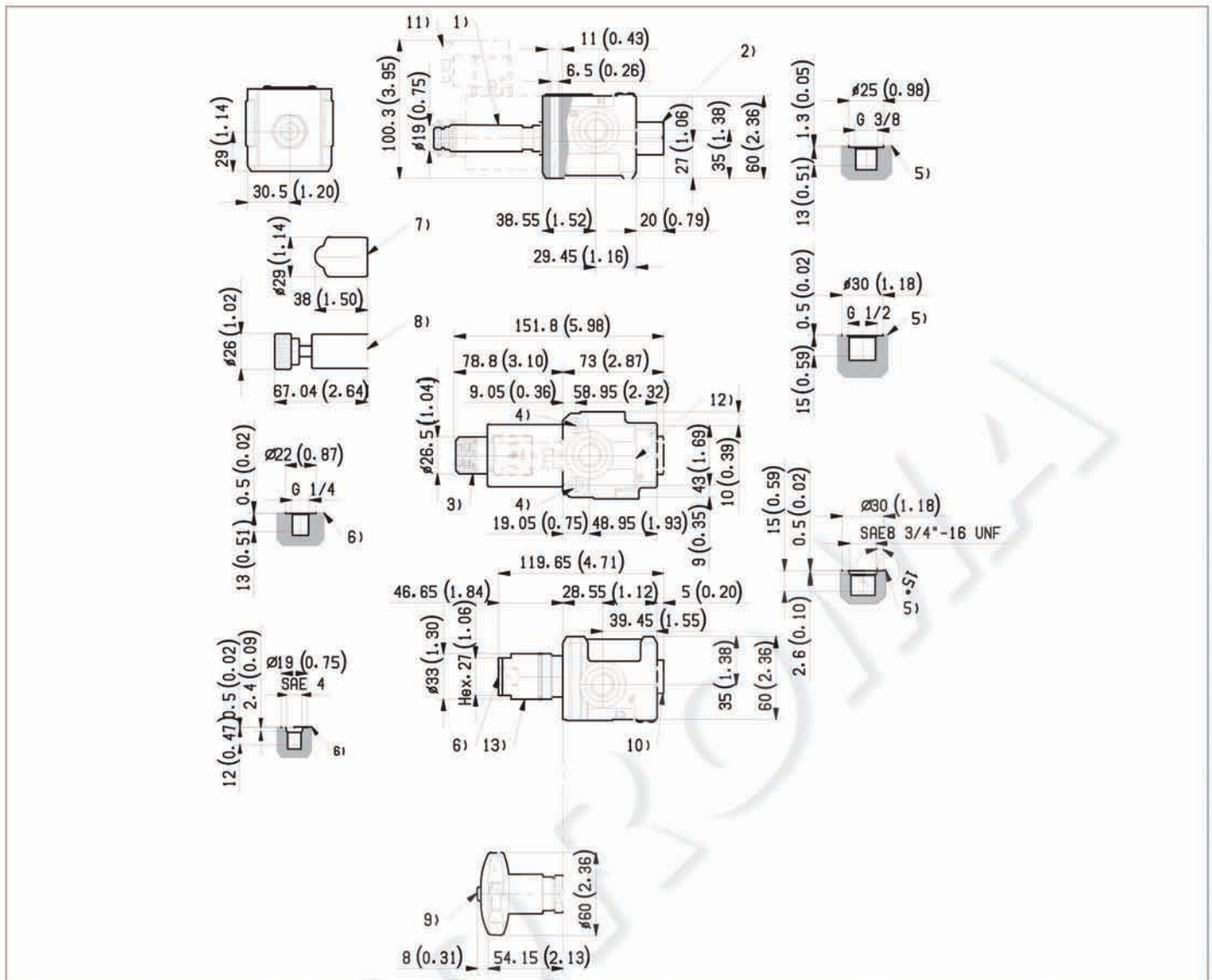

- 1 Solenoid tube \varnothing 19 mm (0.75 inch).
- 2 Plug for version with external drain.
- 3 Ring nut for coil locking \varnothing 26.5 mm (1.04 inch).
Torque 5-6Nm (3.6-4.4 ft-lb).
- 4 Two through holes for installation.
Recommended screws M6 with strength class DIN 8.8.
Torque 9-10 Nm (6.6-7.4 ft-lb).
- 5 Ports P, C1, C2: G 3/8, G 1/2, SAE 8.
- 6 External drain and hydraulic, or pneumatic pilot port G 1/4, SAE 4.
- 7 Optional push-button type manual override for spool opening: it is pressure stuck to the ring nut for coil locking.
Mat no. R933000043.
- 8 Optional screw type manual override for spool opening: it is screwed (torque 6-7Nm (4.4-5.2 ft-lb)) to the tube as replacement of the coil ring nut. Mat no. R933007215.
- 9 Dimensions of optional manual version, push and twist type.
- 10 Plug for version with internal drain.
- 11 Minimum clearance needed for connector removal.
- 12 Identification label.
- 13 Hydraulic, or pneumatic pilot connector.

Electric connection

